

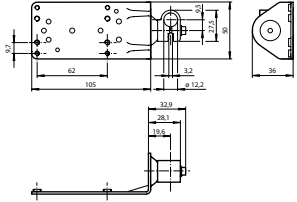

Brackets for F 25, FL 20, UT 20 (Cont.)			
		153-01040	Part number / Article number
			Description
			Suitable for
			MZ F 25 / 661-01003
			Mounting adapter for FT 25 contrast sensors with horizontal or vertical light exit options, with screws Material: stainless steel V2A
			FT 25-W...-KL4 FT 25-RGB...-KL4

Brackets for F 50, F 55, F 88, FGL series			
		153-01164	Part number / Article number
			Description
			Suitable for
			MB ST2 / 661-01007
			Mounting component for Ø 12 mm mounting rod and 10 x 10 mm square profile, and F 55 and fork sensors (FGL), with M4 screw Material: die-cast zinc
			F 55, FGL, MST 45-20, MST 45-30, MST 45-40
		153-01287	Part number / Article number
			Description
		153-01288	Suitable for
			MBD F 55ST2 / 579-50012
			Mounting component for F 55 metall housing for bar Ø 12 mm or squared profile 10 x 10 mm, with M4 screw and M4 nut Material: die-cast zinc
			F 55 metall housing
		153-00065	Part number / Article number
			Description
			Suitable for
			MS F 50 / 579-50000
			Angle bracket with screws Material: stainless steel VA
			F 50 F 55
		153-00298	Part number / Article number
			Description
			Suitable for
			MSP F 50 / 579-50005
			Protective sensor angle bracket with screws, very robust, light exit possible on three sides Material: stainless steel VA
			F 50

Brackets for F 50, F 55, F 88, FGL series (Cont.)			
		<p>Part number / Article number</p> <p>Description</p> <p>Suitable for</p>	<p>MS F 88-3 / 820-41003</p> <p>Bracket for mounting rod with joint for fine adjustment, with screws</p> <p>Material: metal</p> <p>F 88</p>
		<p>Part number / Article number</p> <p>Description</p> <p>Suitable for</p>	<p>MB ST2 / 661-01007</p> <p>Mounting component for \varnothing 12 mm mounting rod and 10 x 10 mm square profile, and F 55 and fork sensors (FGL), with M4 screw</p> <p>Material: die-cast zinc</p> <p>F 55, FGL, MST 45-20, MST 45-30, MST 45-40</p>



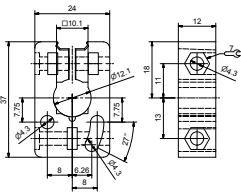



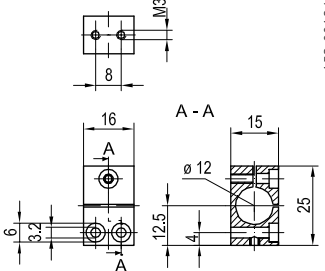

Accessories

Brackets

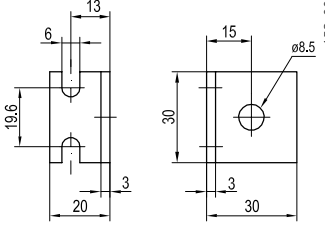
Brackets for fibre-optic cables and round housings

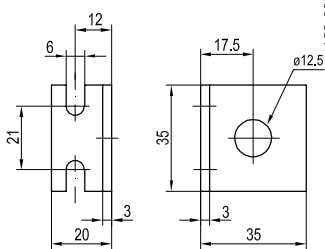

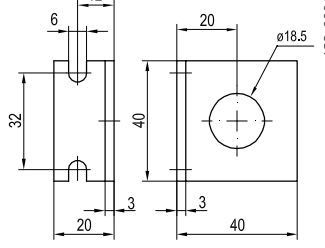

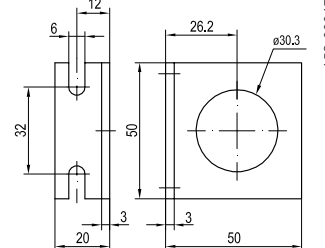

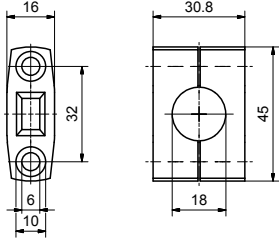
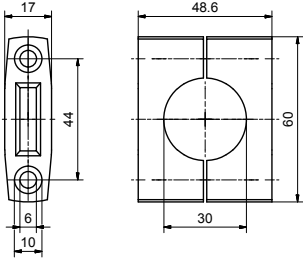

Brackets for fibre-optic cables and round housings		Part number / Article number	Description	Suitable for
	153-00193	MB 3,5 / 903-50313	Mounting block / fibre mount, closed curve Material: nickel-plated brass	Fibre-optic cables
	153-00234	MB 4,5 / 903-50314	Mounting block / fibre mount, open curve Material: nickel-plated brass	Fibre-optic cables
	153-00194	MB 6 / 903-05139	Mounting block / fibre mount, open curve Material: nickel-plated brass	Fibre-optic cables
	153-00195	MB 7 / 903-05140	Mounting block / fibre mount, open curve Material: nickel-plated brass	Fibre-optic cables
	153-00235	MB 8 / 903-05141	Mounting block / fibre mount, open curve Material: nickel-plated brass	Fibre-optic cables, round M8 housings
	153-00236	MB 10 / 903-05142	Mounting block / fibre mount, open curve Material: nickel-plated brass	Fibre-optic cables, round M10 housings

Brackets for fibre-optic cables and round housings (Cont.)			
	 <p>153-00196</p>	<p>Part number / Article number</p> <p>Description</p> <p>Suitable for</p>	<p>MB 12 / 903-05143</p> <p>Mounting block / fibre mount, closed curve Material: nickel-plated brass</p> <p>Fibre-optic cables, round M12 housings</p>
	 <p>153-00559</p>	<p>Part number / Article number</p> <p>Description</p> <p>Suitable for</p>	<p>MC 08 / 041-01306</p> <p>Mounting angle for round housings Material: aluminium</p> <p>Round M8 housings</p>
	 <p>153-00558</p>	<p>Part number / Article number</p> <p>Description</p> <p>Suitable for</p>	<p>MA 12 / 041-01305</p> <p>Mounting angle for round housings Material: aluminium</p> <p>Round M12 housings</p>
	 <p>153-00015</p>	<p>Part number / Article number</p> <p>Description</p> <p>Suitable for</p>	<p>MA 18 / 041-01304</p> <p>Mounting angle for round housings Material: aluminium</p> <p>Round M18 housings</p>
	 <p>153-00017</p>	<p>Part number / Article number</p> <p>Description</p> <p>Suitable for</p>	<p>MA 30 / 041-01303</p> <p>Mounting angle for round housings Material: aluminium</p> <p>Round M30 housings</p>

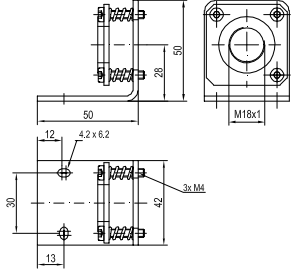
Accessories

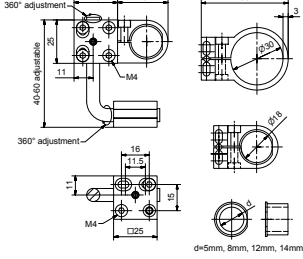
Brackets

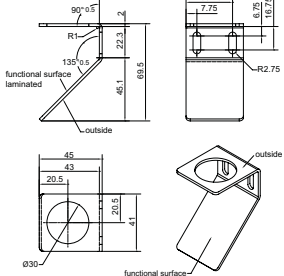
Brackets for fibre-optic cables and round housings (Cont.)			
		153-00016	Part number / Article number MC 18 / 042-01528 Description Retaining clip for round housings Material: plastic Suitable for Round M18 housings
		153-00018	Part number / Article number MC 30 / 042-01527 Description Retaining clip for round housings Material: plastic Suitable for Round M30 housings
		153-00059	Part number / Article number MA 18 A / 042-12825 Description Universal mounting angle for round housings, fine-adjustable with adjusting screws Material: galvanised steel Suitable for Round M12 and M18 housings
		153-01016	Part number / Article number MS M5-30 / 558-41012 Description Universal bracket for round housings Material: connecting rod, metal / mounting elements, plastic Suitable for Round M5, M8, M12, M14, M18 and M30 housings
		153-00959	Part number / Article number Deflection mirror / 691-51535 Description Deflection mirror for ultrasonic sensors Material: stainless steel Suitable for UMT 30-350 UMT 30-1300

Brackets for VISOR®									
		<p>153-00547</p>	<p>Part number / Article number MP 45 / 543-11003</p> <p>Description Mounting plate for mounting rod Material: anodised aluminium</p> <p>Suitable for MST 45-xx</p>						
		<p>153-01000</p>	<p>Part number / Article number MB ST1 / 661-01002</p> <p>Description Mounting for mounting rod with clamping screw Material: aluminium</p> <p>Suitable for MST 45-20 MST 45-30 MST 45-40</p>						
	 <table border="1" data-bbox="614 954 842 1066"> <tr> <td>x = 200</td> <td>MST 45-20</td> </tr> <tr> <td>x = 300</td> <td>MST 45-30</td> </tr> <tr> <td>x = 400</td> <td>MST 45-40</td> </tr> </table>	x = 200	MST 45-20	x = 300	MST 45-30	x = 400	MST 45-40	<p>153-00545</p>	<p>Part number / Article number MST 45-20 / 543-11005 MST 45-30 / 543-11006 MST 45-40 / 543-11007</p> <p>Description Mounting rod with M6 internal thread Material: stainless steel</p> <p>Suitable for MP 45, MB ST 1, MG 45, MB 45, MZ 45</p>
x = 200	MST 45-20								
x = 300	MST 45-30								
x = 400	MST 45-40								
		<p>153-00776</p>	<p>Part number / Article number MG 45 / 543-11008</p> <p>Description Mounting hinge for mounting rod Material: anodised aluminium, steel screw with plastic handle</p> <p>Suitable for MST 45-xx</p>						
		<p>153-00546</p>	<p>Part number / Article number MZ 45 / 543-11004</p> <p>Description Intermediate mounting piece for mounting rod Material: anodised aluminium</p> <p>Suitable for MST 45-xx</p>						
		<p>153-00481</p>	<p>Part number / Article number MB 45 / 543-11002</p> <p>Description Mounting block for mounting rod Material: anodised aluminium</p> <p>Suitable for MST 45-xx MA 45 MA 45 L</p>						

Accessories









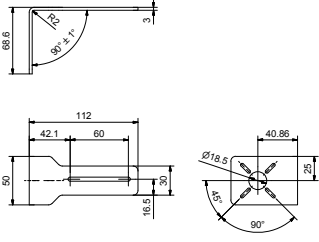

Brackets

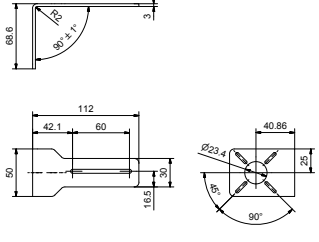
Brackets for VISOR® (Cont.)			
		<p>Part number / Article number</p> <hr/> <p>Description</p> <hr/> <p>Suitable for</p>	<p>MA 45 / 543-11001</p>
			<p>MA 45 / 543-11001</p> <p>Mounting angle</p> <p>Material: stainless steel V2A</p> <p>MK 45</p> <p>MK 45 L</p> <p>MB 45</p>
		<p>Part number / Article number</p> <hr/> <p>Description</p> <hr/> <p>Suitable for</p>	<p>MA 45 L / 543-11013</p>
			<p>MA 45 L / 543-11013</p> <p>Mounting angle, long</p> <p>Material: stainless steel V2A</p> <p>MK 45</p> <p>MK 45 L</p> <p>MB 45</p>
		<p>Part number / Article number</p> <hr/> <p>Description</p> <hr/> <p>Suitable for</p>	<p>MK 45 / 543-11000</p>
			<p>MK 45 / 543-11000</p> <p>Mounting clamp, dovetail</p> <p>Material: anodised aluminium</p> <p>Screw: steel</p> <p>VISOR®</p>
		<p>Part number / Article number</p> <hr/> <p>Description</p> <hr/> <p>Suitable for</p>	<p>MK 45 L / 543-11021</p>
			<p>MK 45 L / 543-11021</p> <p>Mounting clamp, dovetail, long</p> <p>Material: anodised aluminium,</p> <p>Screw: steel</p> <p>VISOR®</p>
		<p>Part number / Article number</p> <hr/> <p>Description</p> <hr/> <p>Suitable for</p>	<p>MA 45-63/105 UR / 543-11043</p>
			<p>MA 45-63/105 UR / 543-11043</p> <p>Mounting angle for VISOR® for UR robot</p> <p>Material: aluminium</p> <p>VISOR®</p>

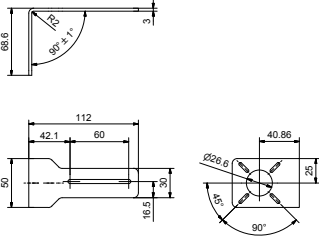
Brackets for VISOR® (Cont.)			
		<p>153-01181</p> <p>Part number / Article number</p> <p>Description</p> <p>Suitable for</p>	<p>MG 3A / 543-11024</p> <p>Mounting hinge with 3 axes and drilled hole for mounting rod</p> <p>Material: anodised aluminium</p> <p>VISOR®</p>
		<p>153-12583</p> <p>Part number / Article number</p> <p>Description</p> <p>Suitable for</p>	<p>MG 3A-MST12 / 543-11034</p> <p>Mounting hinge with 3 axes for fixing at mounting rods 12 mm</p> <p>Material: anodised aluminium</p> <p>VISOR®</p>
<p>200</p> <p>210</p> <p>100</p> <p>Mounting hinge (MG 45)</p> <p>Mounting block, rod (MB 45)</p> <p>Mounting angle (MA 45)</p> <p>Mounting clamp, dovetail (MK 45)</p> <p>Mounting rod (MST 45-x)</p> <p>Mounting plate (MP 45)</p> <p>Mounting rod (MST 45-x)</p> <p>153-00435</p>			

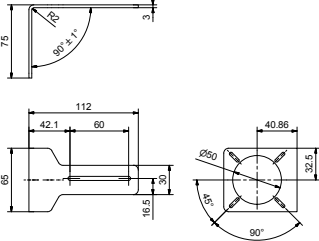
Accessories

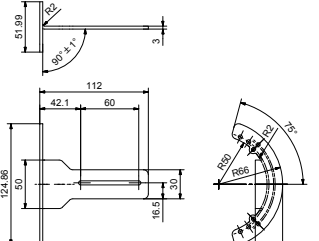
Brackets

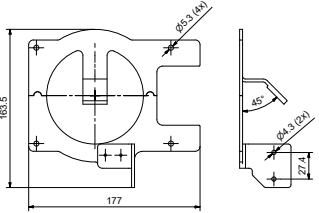
Brackets for illumination			
		<p>153-00707</p>	<p>Part number / Article number MA LR-18/112 / 543-11016</p> <p>Description Angle bracket for lighting, Ø 18 mm Length: 112 mm Material: nickel-plated steel</p> <p>Suitable for LR 32 x-24-KFL5 LD 50 xD-24-KFL5</p>
		<p>153-00721</p>	<p>Part number / Article number MA LR-23/112 / 543-11019</p> <p>Description Angle bracket for lighting, Ø 23 mm Length: 112 mm Material: nickel-plated steel</p> <p>Suitable for LR 56 x-24-KFL5 LR 70 xD-24-KFL5 LR 70 xID-24-KFL5</p>
		<p>153-00722</p>	<p>Part number / Article number MA LR-26/112 / 543-11017</p> <p>Description Angle bracket for lighting, Ø 26 mm Length: 112 mm Material: nickel-plated steel</p> <p>Suitable for LR 50 xW-24-KFL5 LR 70 x-24-KFL5</p>
		<p>153-00723</p>	<p>Part number / Article number MA LR-50/112 / 543-11018</p> <p>Description Angle bracket for lighting, Ø 50 mm Length: 112 mm Material: nickel-plated steel</p> <p>Suitable for LR 74 xW-24-KFL5 LR 75 xI-24-KFL5 LR 90 xW-24-KFL5 LR 100 xID-24-KFL5</p>
		<p>153-00724</p>	<p>Part number / Article number MA LR-100/112 / 543-11015</p> <p>Description Angle bracket for lighting, Ø 100 mm Length: 112 mm Material: nickel-plated steel</p> <p>Suitable for LM 100 WWK-24Q4-2L12 LM 100 RWK-24Q4-2L12 LR 100 xD-24-KFL5 LR 130 xI-24-KFL5 LR 132 xW-24-KFL LFR 115 xD-24-2L12</p>
		<p>153-13652</p>	<p>Part number / Article number MA LR-100/160-U90 / 543-11045</p> <p>Description Retaining bracket illumination ring light, Ø 100 mm with deflector mirror 90° Material: stainless steel</p> <p>Suitable for LR 100 RI-24-2L12</p>

Brackets for illumination (Cont.)

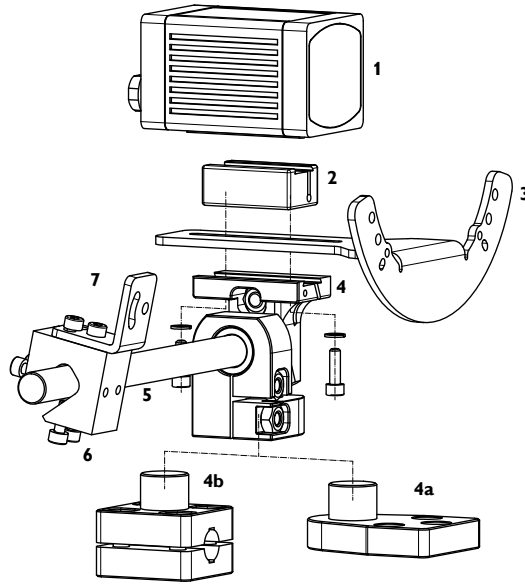

155-03518

- 1** VISOR®
- 2** Mounting clamp, dovetail, long
MK 45 L / 543-11021
- 3** Angle bracket for lighting:
MA LR-100/112 / 543-11015
MA LR-18/112 / 543-11016
MA LR-26/112 / 543-11017
MA LR-50/112 / 543-11018
MA LR-23/112 / 543-11019
- 4** Mounting hinge with 3 axes
*for fixing at mounting rods 12 mm
- 4a** MG 3A / 543-11024
- 4b** *MG 3A-MST12 / 543-11034
- 5** Mounting Rod MST
MST 45-20 / 543-11005
MST 45-30 / 543-11006
MST 45-40 / 543-11007
- 6** Mounting block MB / 45 543-11002
- 7** Mounting angle MA 45 / 543-11001
Mounting angle MA 45L / 543-11013

Brackets for light strips, High Power, LBxxx

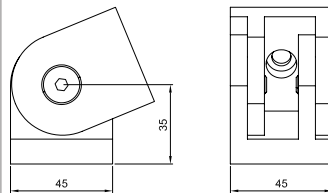

153-01178

Part number / Article number

MG LB L / 543-11025

Description

Mounting hinge light strip long
Material: nickel-plated steel

Suitable for

Light strips High Power, LBxxx

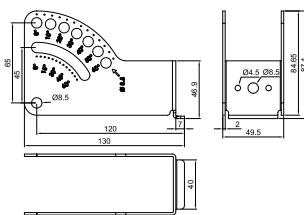

153-01179

Part number / Article number

MG LB LL / 543-11026

Description

Mounting angle light strip long, lite
Material: anodised aluminium

Suitable for

Light strips High Power, LBxxx